

SOUNDSTREAM®

T E C H N O L O G I E S



Don't be a fool by throwing away this manual! Grab a couple brews, sit on your butt & READ THIS! You will NOT be able to set this amplifier properly unless you thoroughly understand the sophisticated pre-amp section of the amplifier. You are now the owner of what may be the finest car audio amplifier ever made. Please read this manual in its entirety. These brand new, long-awaited Reference amplifiers are the finest amplifiers we have ever produced and they WILL change the way you hear and feel music...

REF1.500
REF1.1000

REF2.370
REF2.640

REF4.400
REF4.760
REF4.920



Table of Contents

Reference Lives	3
Features	4-5
Specifications	6
Installation	7
Controls and Terminals	8-10
Control Definitions	11-13
System Diagrams	14-17
Subwoofer Diagrams	18-19
Troubleshooting	20

Reference Lives!

Can you believe that it has been over a decade since the legendary Soundstream Reference amps graced the car audio industry?! Maybe you bought this amplifier because the best amplifier you ever had was a Reference from back in the day. Maybe you bought it for its legendary performance. Regardless of the reason, we know you'll love your new SS Ref & will appreciate its unparalleled quality.

When we first decided to reintroduce the coveted amplifiers, we just wanted something as fine as the originals. They were finer than most amplifiers in the marketplace today. After failing to deliver for a couple of years, we decided to hold back until we were 100% certain that there was nothing else we could do to make the amplifiers any better. Many crappy clone amps popped up in Germany and Asia, but none were real Soundstream Reference amplifiers, and they certainly did not come from us. We feel confident that we came up with everything you'd ever want. The preamp controls are extensive. The circuitry is very advanced. Even the painstaking task of making sure every board trace is in the perfect location yielded phenomenal results – damping factors from >1500 to >3000! Don't fall for the foolish tale that this doesn't matter! The ability of an amplifier to accurately control the speaker is of critical importance! Duh!

Most amplifier manuals get thrown in the trash or never even make it out of the box. The new Ref amps are very sophisticated and the silk screening on the front of the amplifier cannot begin to unfurl the powers of the new preamp sections. It would not be wise to ditch this manual without thoroughly reading it over first. So grab a beer, a glass of wine or a stupid latte and take a few minutes to chill out and absorb the intensity of the new SS Refs. Actually, if you are reaching for a latte, you're a fruitcake and do not deserve this amplifier. Grow a pair! Grab a 6-pack of your favorite microbrew and read the freakin' manual!!

*Note – while drinking some great beer is one of life's greatest pleasures, please do not drink the whole 6-pack and attempt to work with electronics. Drinking fizzy, yellow light beer is for wussies and will probably make your amplifier spontaneously combust. Seriously, it happens. Soundstream engineers are willing to install your amplifier for you if you send them a plane ticket for two and cover all expenses, including great beer.

Features

In the 80s, it became popular to use acronyms for amplifier features and technologies. In some cases, these acronyms were nothing more than fancy words put together cleverly to form an acronym not worth its weight in poop! Sales people memorized the silly acronyms but rarely knew what the feature encompassed. The features below are straight forward facts about the amplifiers that make them yield audio nirvana.

General:

- Full Signal Path Low Noise/Distortion Circuitry Topology
- Optimal Component Layout for Minimal Distortion Induction & Signal Separation
- Full Differential Feedback Surrounding Power-Amp Stages directly from Speaker Terminals resulting in Uncolored Sound Reproduction and Elimination of Ground Loops
- Differential Drives Divide Pre-Amp & Power-Amp Stages, Eliminating Ground Looping
- Triple Darlington Audio Output Stages
- Output Stage Bias Individually Sequenced, Optimizing Sound Quality
- Close Tolerance Signal Path Components - 1% Resistors & 5% Capacitors
- Stout 2 Oz. Copper Traces Effortlessly Transfer High Volume Internal Current
- Differential RCA Inputs Isolate 12V/Audio to Ground, Eliminating Ground Loops and Noise
- Sequenced Delays Eliminate Residual Power-Up/Power-Down Pops
- Final PCB Layout Designs are a culmination of examination and fine tuning of all circuit elements to work in harmony as a whole
- Hawkins Boost Control - Proprietary Bass Equalization
- Continuously Variable Crossovers
- Tri-Mode Capable

PSU

- Pulse Width Modulated
- Large TO218 MOSFET Transistors
- High Volume, Low ESR Capacitance Banks Compensate Power Supply Ripple Currents
- Extra Low Current Drive Stage Increases Efficiency & Sound Clarity
- Individually Regulated Preamp/Crossover Power Supplies Ensure Signal Purity
- Separated Capacitor Charging/Discharging Current Paths Prevent Rail Switching Spikes & Ground Traces from Entering Signal Stages Resulting in Distortion

Mono-block Models:

- True Class G Circuitry and Regulated MOSFET Power Supply. This allows the Subwoofer Amplifiers to Yield the Same POWER at 1-2 ohms, and Regardless of Operating DC Voltage. (You can use almost any amount of woofers, and of any impedance, and wire it to the amplifier safely! See the options in the back of the manual...)

Common Specifications
Bass Boost 0-12dB 30Hz - 80Hz
Input Sensitivity 0.2V - 9V
Total Harmonic Distortion <0.02%
Supply Voltage 11-15VDC
Stereo Stability 2 Ohms
Bridged Stability 4 Ohms
Monoblock Stability 1 Ohm
Input Impedance 10k Ohms

SPECIFICATIONS	REF2.370	REF2.640	REF4.400	REF4.760	REF4.920	REF1.500	REF1.1000
Channels	2	2	4	4	4	1	1
RMS Power @ 4Ω, 14.4V	2 x 110	2 x 190	4 x 70	4 x 115	4 x 145	-	-
RMS Power @ 2Ω, 14.4V	2 x 185	2 x 320	4 x 100	4 x 155	4 x 215	500	1000
RMS Power @ 4Ω Bridged, 14.4V	1 x 370	1 x 640	2 x 200	2 x 380	2 x 460	-	-
RMS Power @ 1Ω, 14.4V	-	-	-	-	-	500	1000
Total Harmonic Distortion (4Ω power)	0.02%	0.02%	0.02%	0.02%	0.02%	0.02%	0.02%
Frequency Response	15-50kHz	15-50kHz	15-50kHz	15-50kHz	15-50kHz	15-200Hz	15-200Hz
Signal-to-Noise Ratio (4Ω power)	102dB	102dB	102dB	102dB	104dB	102dB	102dB
Damping Factor (100Hz, 4Ω)	>3000	>1500	>2000	>3000	>2000	>2000	>2000
Dimensions: 2.25"h x 9.875"w 55mm x 250mm	13.58" 345mm	15.94" 405mm	16.06" 408mm	20.25" 514.5mm	22.81" 579.5mm	14.05" 357mm	18.17" 461.5mm
Ch. 1&2 HPF/Hawkins/Subsonic (12dB Slope / 0-10dB Hawkins Boost)	15-240Hz or 275-4.1kHz	15-210Hz or 260-4kHz	15Hz-4kHz	15Hz-4kHz	15-240Hz or 240-4.1kHz	-	-
Channels 1&2 LPF (12dB Slope)	50-210Hz or 820-4kHz	50-250Hz or 820-4.7kHz	-	-	-	50-200Hz	50-200Hz
Channels 3&4 HPF (12dB Slope)	-	-	15Hz-1kHz	15Hz-4kHz	15-220Hz or 255-4.1kHz	-	-
Channels 3&4 LPF (12dB Slope)	-	-	55Hz-4.3kHz	50Hz-4kHz	50-250Hz or 800-3.8kHz	-	-
Subsonic Filter Slope 12dB	-	-	-	-	-	24dB 15-50Hz	24dB 15-50Hz
Phase Control Switch	-	-	-	-	-	0 or 180°	0 or 180°
Remote Gain Control	-	-	-	-	-	Included	Included
External Fuse Required	40	80	50	80	100	80	150

Installation

Before installing any audio equipment, it is good practice to disconnect the ground terminal on the battery to avoid damage to the vehicle or audio equipment. Failure to do this means you're a few brews short of a 6-pack and you probably already acquired the nickname of "Sparky" or "Smokey". Not cool! Do NOT hook the ground cable back up to the battery until the rest of the wiring is complete.

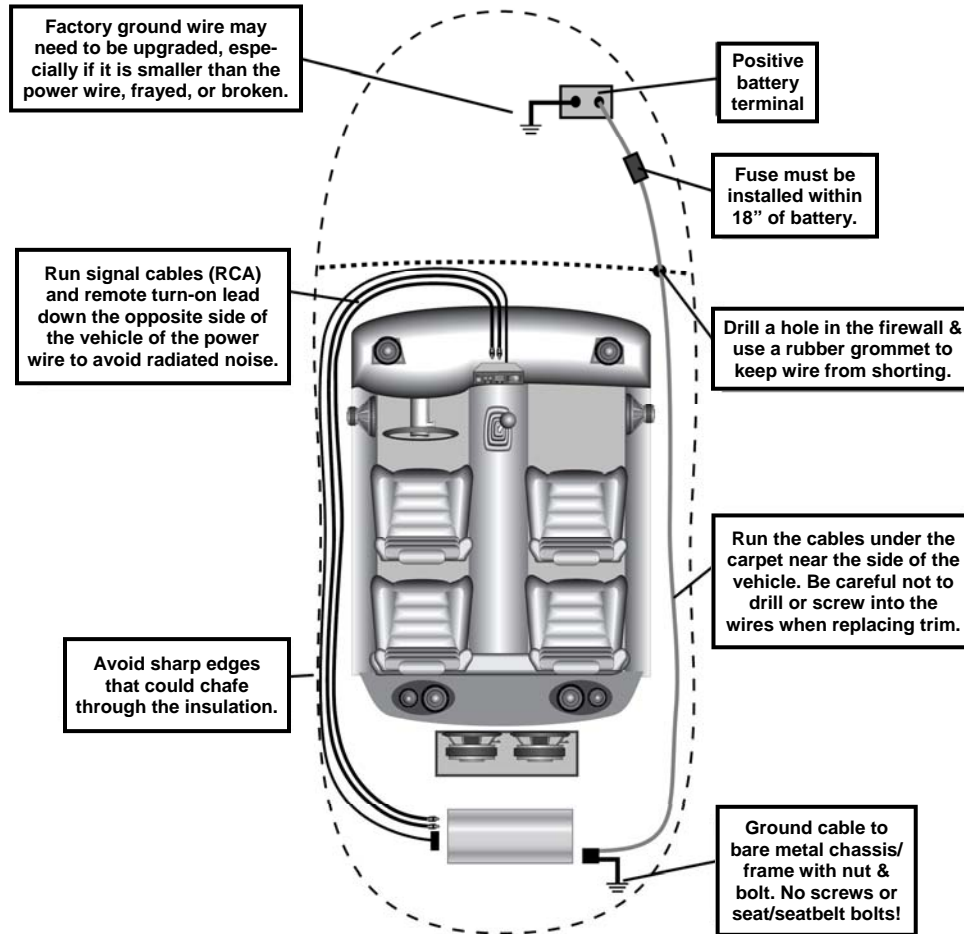

Controls and Terminals

REF2.370

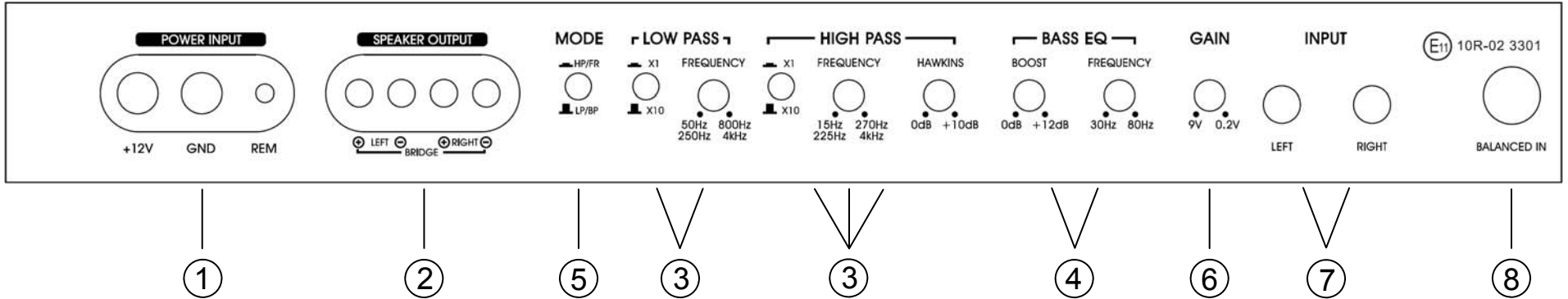

REF2.640

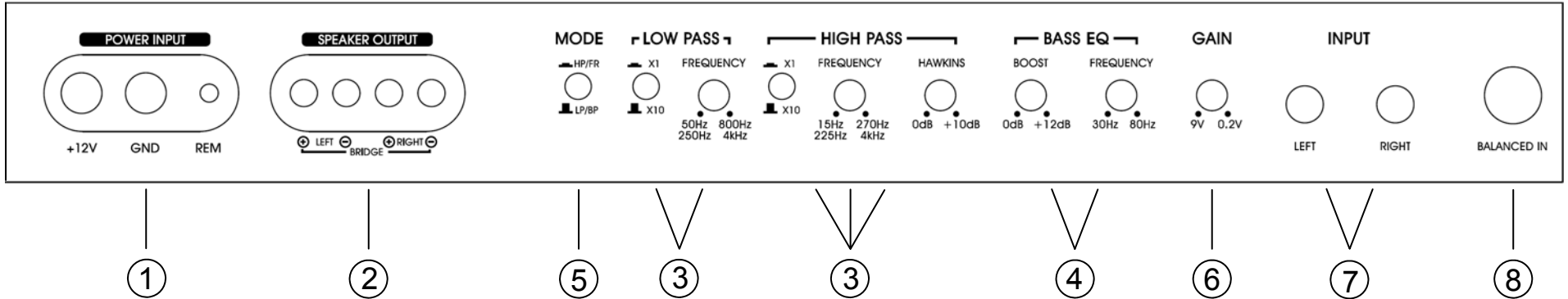

REF4.400

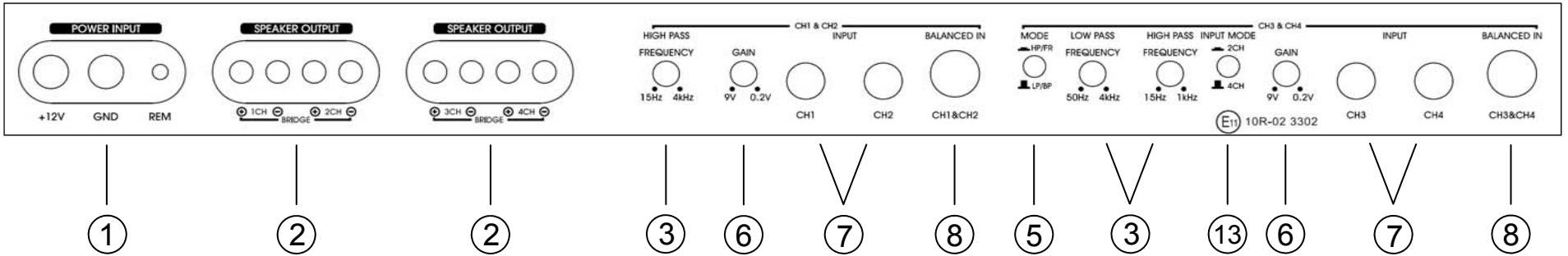

REF4.760

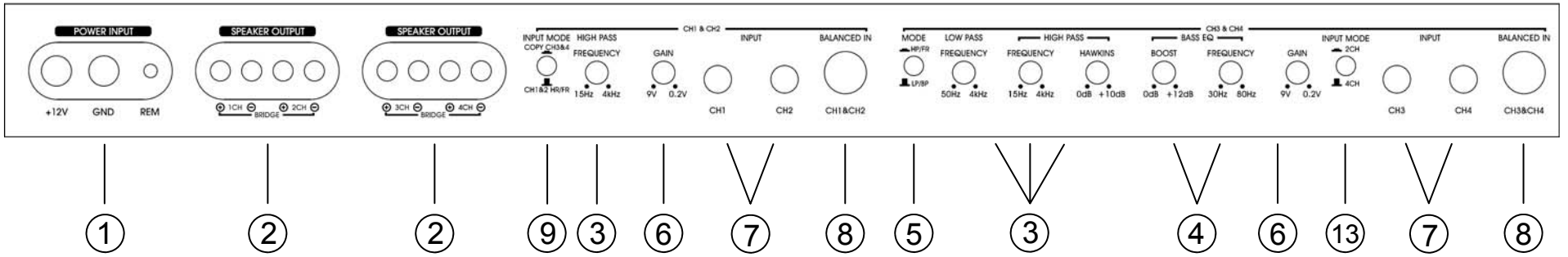

REF4.920

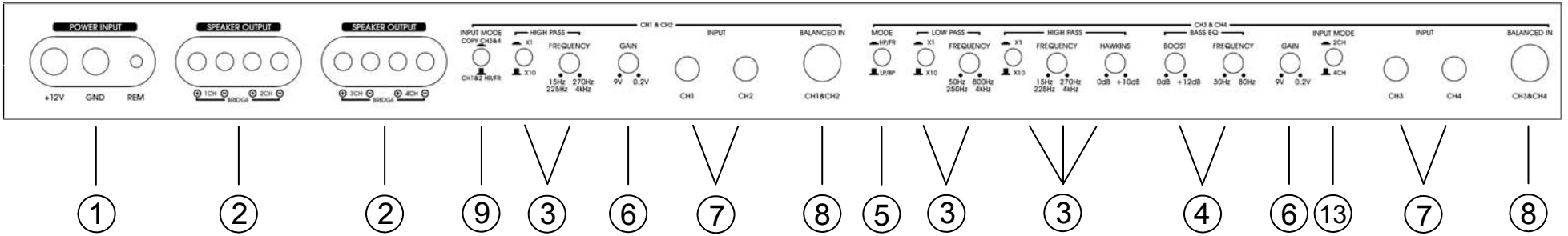

Controls and Terminals

REF1.500

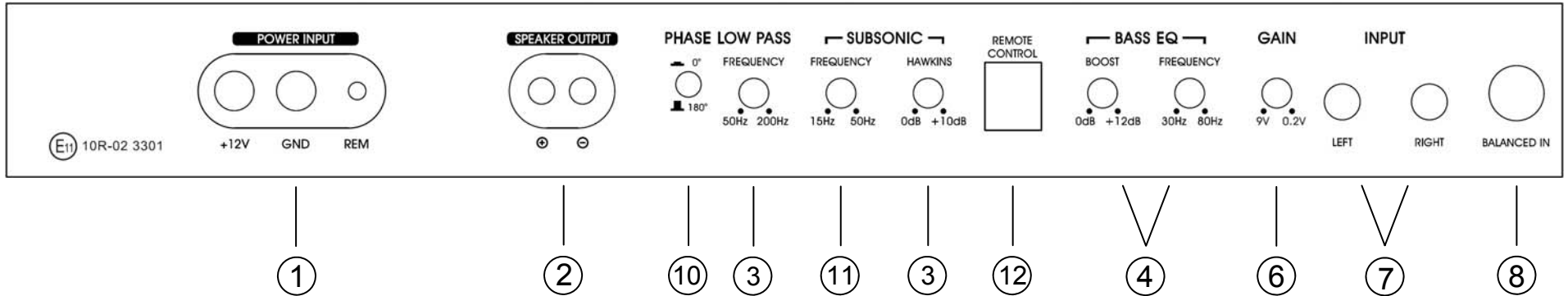

REF1.1000

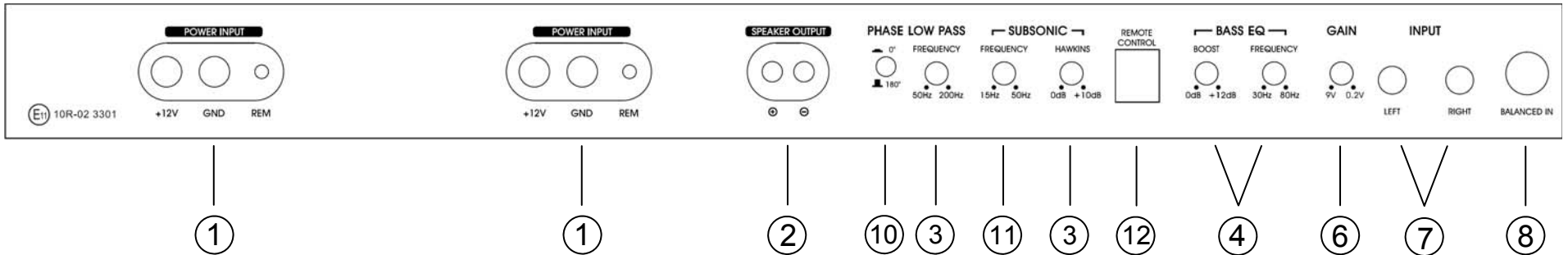

Control Definitions

Alrighty, here comes the fun stuff. We're going to break this down to it simplest form so that there is no way you can possibly do any damage in the installation process to your audio system. We're going to explain in detail how every single knob and switch work rather than turn you loose on a sophisticated amplifier and have problems. READ EVERYTHING! Trust us, it'll be worth it... Before you do anything, undo the ground cable from the battery.

① **Power Terminal Block**

GND – This is the Ground connection. Bolt the Ground cable to a *bare metal* part of the chassis/frame. Do NOT use self-tapping screws or seat/seatbelt bolts!

+12V – This is the Power Connection. This cable gets connected directly to the battery. You MUST use a fuse holder or circuit breaker within 18" of the battery. All cables ran through the firewall must be protected by a rubber or plastic grommet. If you have multiple amplifiers, the main fuse or circuit breaker at the battery should be the sum of all fuses or slightly less.

REM – This is the remote Turn-On connection. Connect to the amplifier output or power antenna output of the source unit. If the unit does not have a switched +12V output, you can use another switchable +12V.

② **Speaker Terminal Block**

This is the Speaker(s) Connection. All components, coaxials and subwoofers connect here.

③ **Crossovers**

These controls allow you to pass and block frequencies to each driver. This is one of the most important parts of tuning any audio system.

LOW PASS – This control allows you to pass only frequencies lower than the frequency you choose to the drivers. For example, if you are powering a sub woofer and you choose 70Hz, then only 70Hz and lower tones will be passed through to the subs while all unwanted higher frequencies above 70Hz will be blocked.

HIGH PASS - This control allows you to pass only frequencies higher than the frequency you choose to the drivers. High Pass crossover filters below 50Hz are also considered "subsonic" filters.

Multiplier Switches – Sometimes you may need a range that is not within the range supplied by the control potentiometer. In this case, if the amplifier has a multiplier switch, the range can change to accommodate your needs. For example, let's say you have a 4 channel amplifier and you want to put the tweeters (1") on the front channels and the midbass (6.5") on the rear channels, and use all electronic crossovers. You can set the High Pass for the tweeters at 4kHz. The low pass, if it has two ranges, may be from 50-800Hz which is not high enough. By using the multiplier switch, that same control can change the range from 50Hz-800Hz to 250Hz-4kHz. If this doesn't make sense and you do not understand frequencies clearly, PLEASE TAKE YOUR AMP TO A PROFESSIONAL SOUNDSTREAM DEALER!

- ③ **Crossovers** (continued)
HAWKINS – This is a patented circuit developed by Soundstream many years ago. Hawkins has 2 controls but 3 functions. One of the controls is the boost and it is from 0-10dB. The second control is the frequency. Whatever frequency you select will be the frequency that is controlled by the adjustable boost. The third function is a tracking subsonic filter. Basically, at the frequency point you choose to boost, all lower frequencies will be blocked by the tracking subsonic filter to avoid damage to speakers. For example, your subwoofer starts to lose output at 50Hz. You can set the frequency to 40Hz and boost up to 10dB, but you do not have to worry about super low frequencies damaging your speakers because no music material below 40Hz will go to the subwoofers. Or, let's say your subwoofer plays just fine, but at 20Hz tones it starts to flutter and get distorted. You can set the Hawkins at 20-25Hz and not use the boost, but still take advantage of the subsonic filter subwoofer protection.
- ④ **Bass EQ** – This circuit allows you to choose a frequency between 30Hz and 80Hz and boost that frequency by 0-12dB.
- ⑤ **Xover Mode Switch** – Select HP/FR for High Pass / Full Range and only the HIGH PASS functions will work. The High Pass filter is never off, but can be set to 15Hz which passes the entire audible spectrum to be reproduced. If you select LP/BP for Low Pass and Band Pass, then the LOW PASS function works as well. You can use the Low Pass in conjunction with the always-on High Pass to band pass the signal to the drivers. For example... Let's say you have 3-way components consisting of a 1" tweeter, 4" midrange and a 6.5" midbass. Your 4" and 1" are on another amplifier. You can set the midbass to play just the midbass frequencies by setting the LOW PASS to 400Hz and setting the high pass to 60Hz. This will effectively give you a dedicated midbass region that will not overlap into the midrange frequencies or subwoofer frequencies.
- ⑥ **Input Gain** – While most people set this control by ear to how loud they want their music, this is not the intent of this control. The range is from 0.2 volts to 9 volts. The control is meant for matching to the source unit's output signal voltage. For example, if you have a unit with low output voltage, you would probably have the control set fairly high, towards the 0.2V range. A lot of head units have 4 volts of signal voltage which mean that your control would be set in midway through the range. If you happen to have a line driver (signal booster) that yields 9 volt or more, you will set the gain at the minimum position. In all of these examples, when properly level matched, the amplifier will put out full volume. Setting the control above the proper point may cause damage to the amplifier and speakers, and can result in poor sound quality and overall undesirable results...
- ⑦ **RCA Signal Inputs** – Ummm... If you do not know what goes here, get over to your local Soundstream dealer immediately!

- ⑧ **Balanced Signal Inputs** – Using our BLT Balanced Line Transmitters, you can achieve balanced, noise-free signal transfer. This is a MUST and no-brainer for any audiophile, sound quality competitor, or anybody serious about their music.
- ⑨ **CH1&2 Signal Mode** – There are two options here for the signal processing. You can either choose CH1&2 HP/FR for High Pass or Full Range operations, or you can choose COPY CH3&4 making channels 1&2 receive the same processing as channels 3&4. This is handy if you want channels 1&2 to be identical to 3&4 or if you need low pass or band pass signal. Understand that this bypasses EVERYTHING so that the front channels are identical to the rear channels.
- ⑩ **Phase Switch** – This switch changes the phase of the woofer from 0 to 180 degrees.
- ⑪ **Subsonic** – Part of the Hawkins circuit, this is a patented circuit developed by Soundstream many years ago. Hawkins has 2 controls but 3 functions. One of the controls is the boost and it is from 0-10dB. The second control is the frequency. Whatever frequency you select will be the frequency that is controlled by the adjustable boost. The third function is a tracking subsonic filter. Once the boost frequency is set, all frequencies below that point are blocked to prevent damage to the speakers. For example, your subwoofer starts to lose output at 50Hz. You can set the frequency to 40Hz and boost up to 10dB, but you do not have to worry about super low frequencies damaging your speakers because no music material below 40Hz will go to the subwoofers. Or, let's say your subwoofer plays just fine, but at 20Hz tones it starts to flutter and get distorted. Hawkins can be set at 25Hz and not use the boost, but still take advantage of the subsonic filter subwoofer protection.
- ⑫ **Remote Control** – This the port for the Remote Control so you can use the supplied unit to control the gain from the front of the vehicle.
- ⑬ **Input Mode** – When in 4CH mode, all 4 channels of signal are required and fadability is in effect. When in 2CH mode, only 2 channels of signal are required and CH1&3 get the same signal, and CH2&4 get the same signal. Fadability is lost in 2CH mode.

System Diagrams

2 CHANNEL SYSTEM DESIGN #1 REF2.370 / REF2.640

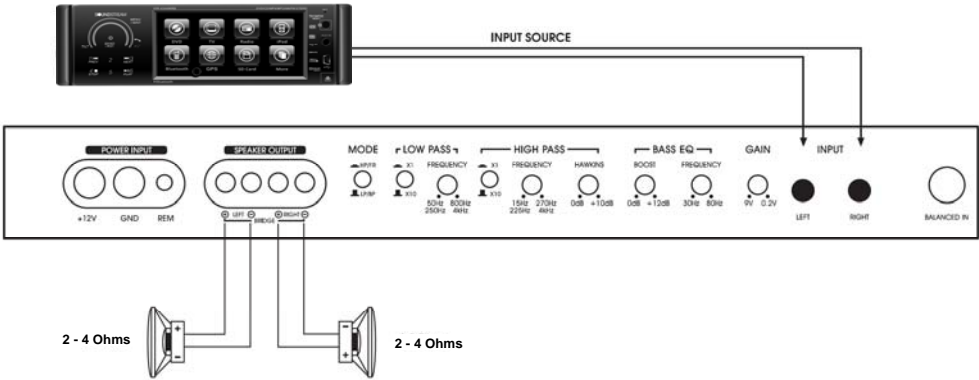

2 CHANNEL SYSTEM DESIGN #2 REF2.370 / REF2.640

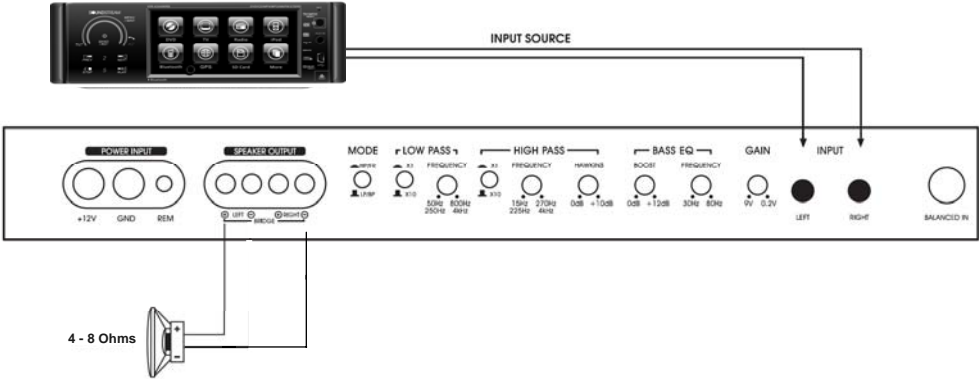

2 CHANNEL SYSTEM DESIGN #3

REF2.370 / REF2.640

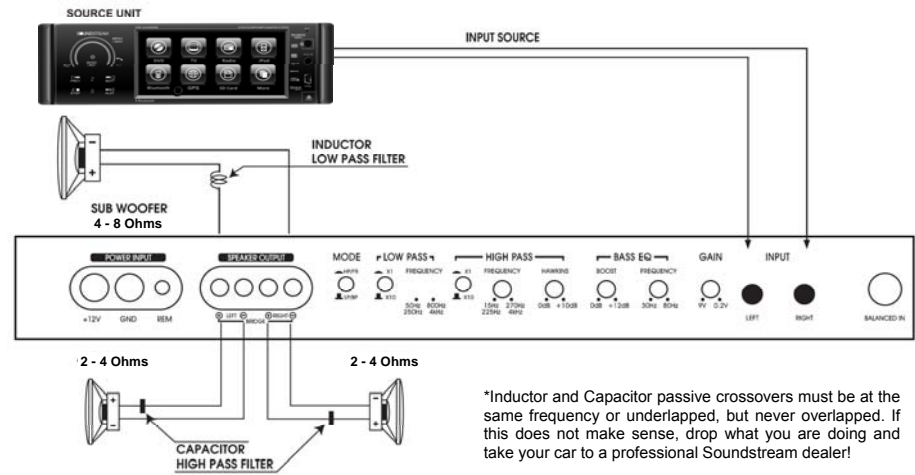

2 CHANNEL SYSTEM DESIGN #4

REF2.370 / REF2.640

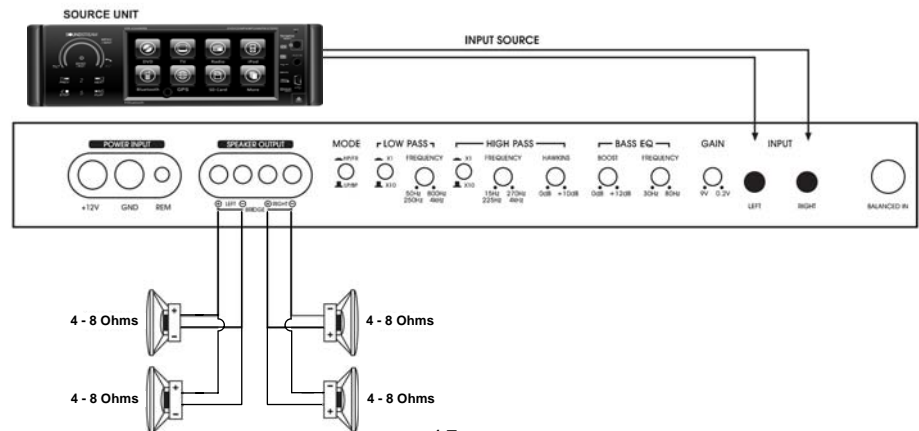

4 CHANNEL SYSTEM DESIGN #1

REF4.760 / REF4.920

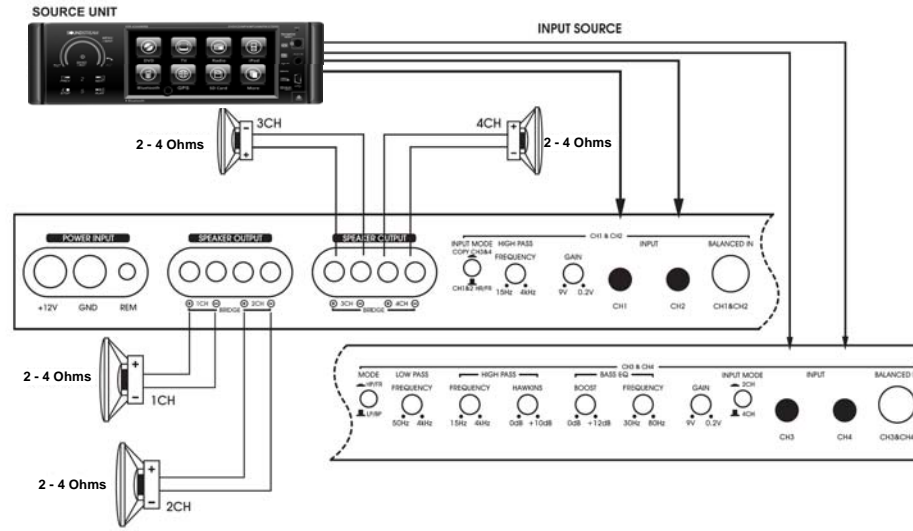

4 CHANNEL SYSTEM DESIGN #2

REF4.760 / REF4.920

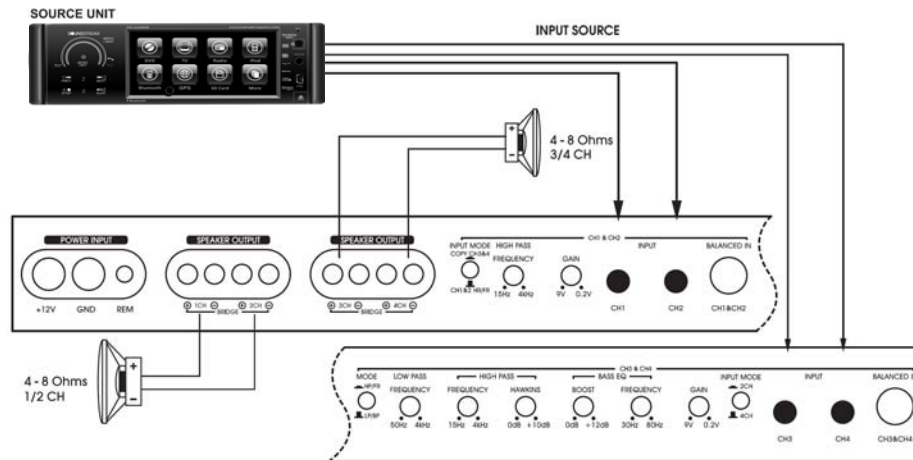

4 CHANNEL SYSTEM DESIGN #3

REF4.760 / REF4.920

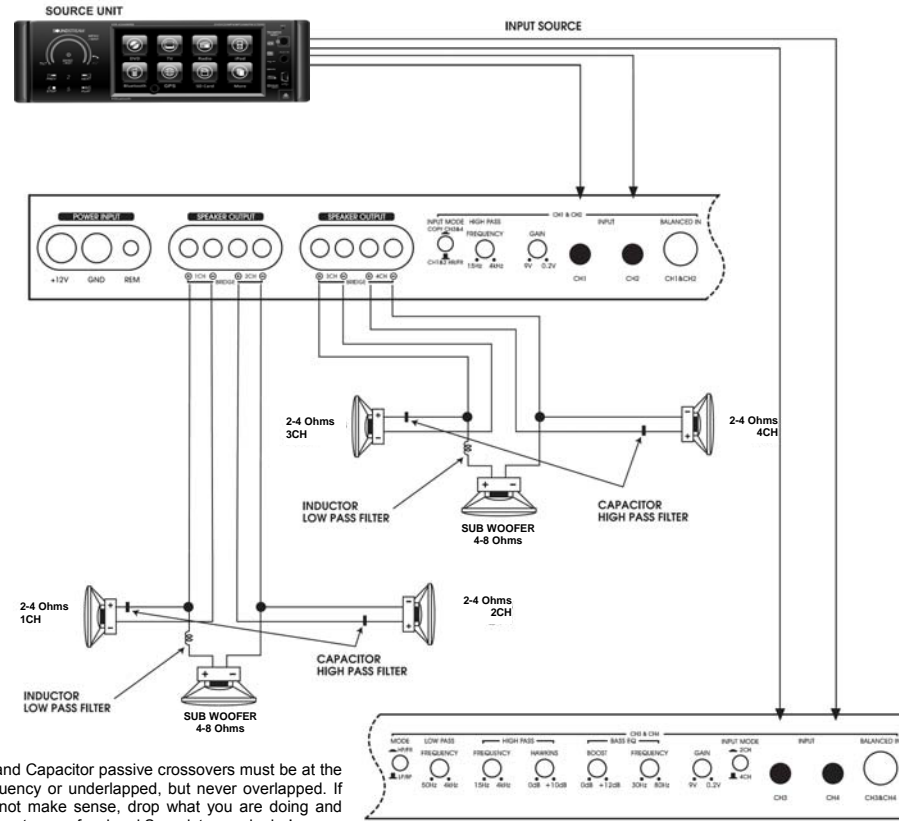

*Inductor and Capacitor passive crossovers must be at the same frequency or underlapped, but never overlapped. If this does not make sense, drop what you are doing and take your car to a professional Soundstream dealer!

Subwoofer Wiring Diagrams

1 CHANNEL SYSTEM DESIGN #1

REF1.500 / REF1.1000

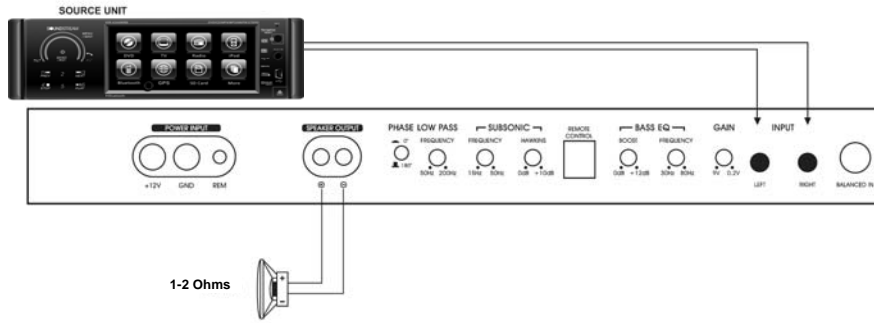

Series-Parallel / Two Dual 2 Ohm
Net Impedance = 2 Ohms

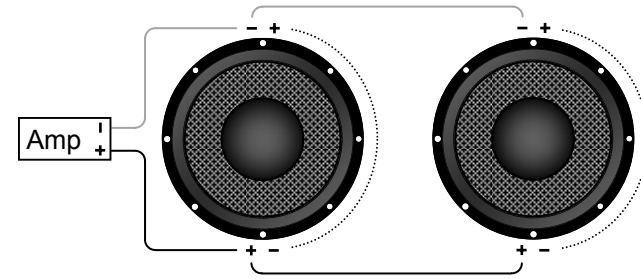

Series-Parallel / Three Dual 2 Ohm
Net Impedance = 1.33 Ohms

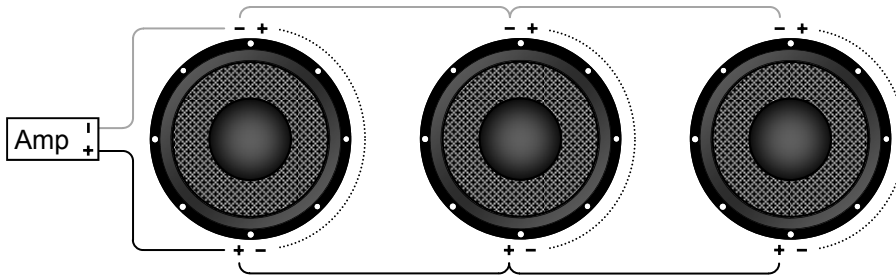

Parallel / Two Dual 4 Ohm
Net Impedance = 1 Ohm

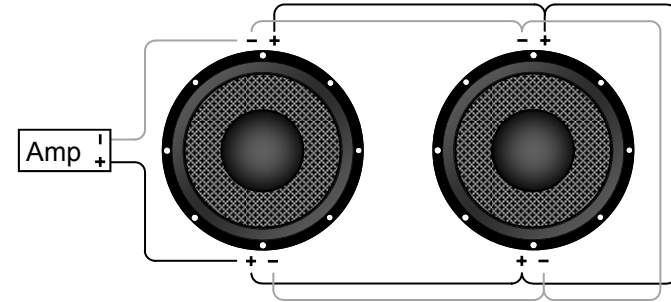

Parallel / Three Single 4 Ohm
Net Impedance = 1.33 Ohms

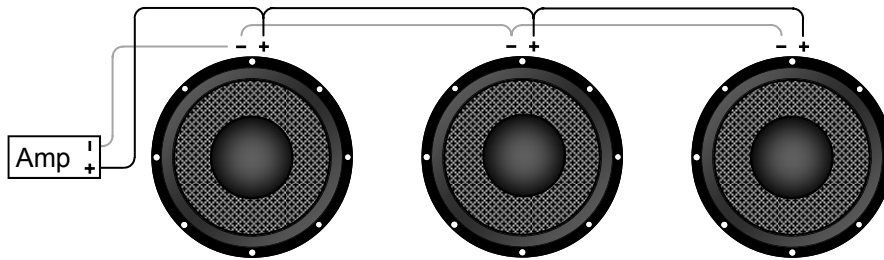

Parallel / Two Single 4 Ohm
Net Impedance = 2 Ohm

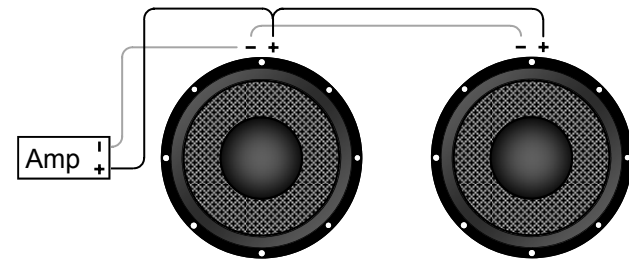

Subwoofer Wiring Diagrams

Series-Parallel / Four Dual 2 Ohm
Net Impedance = 1 Ohm

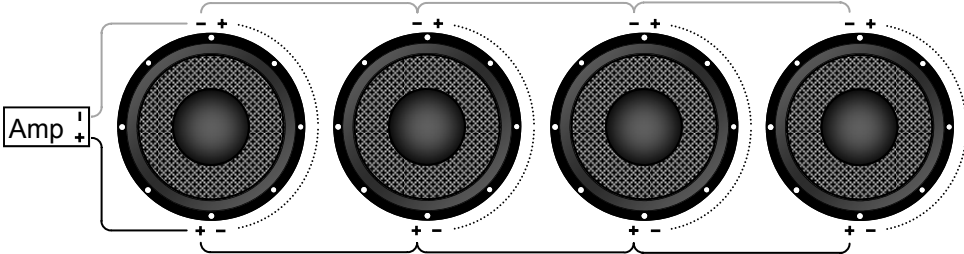

Series-Parallel / Four Dual 4 Ohm
Net Impedance = 2 Ohm

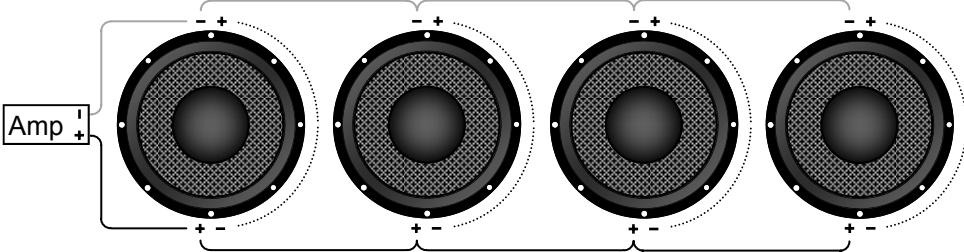

Series-Parallel / Four Single 4 Ohm
Net Impedance = 1 Ohm

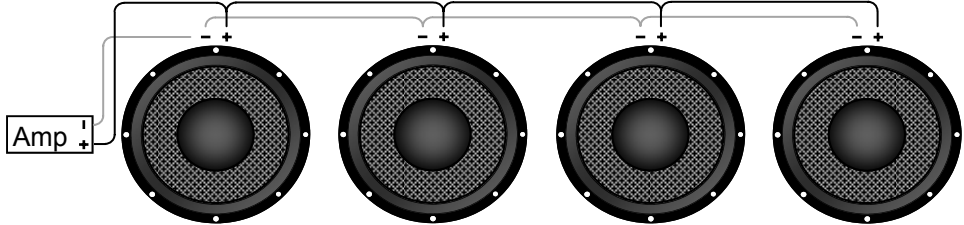

Troubleshooting

SYMPTOM	CHECK	REMEDY
NO SOUND	Is the Status LED illuminated GREEN? NO?	Check all fuses to the amplifier
		Confirm remote turn-on lead is connected at the amp and at the radio/switched +12Volts
		Clean contacts on fuse holder
		Verify ground is secure
	Is the Status LED illuminated GREEN? Yes?	Check gain on amp
		Check source level volume
Check for Speaker or wire short		
AMP NOT SWITCHING ON	No power to power wire	Re-secure power cable
	Poor Ground	Must have bare metal ground
	Does remote wire have +12V	Check at source and amp
	Check fuses	Burnt, broken, detached?
NO SOUND ON ONE CHANNEL	Check speaker wire	Look for shorts, pinches or disconnected terminal
	Check RCAs	Swap left with right. If the bad side began working, the problem is before the amplifier
AMP SHUTS DOWN	Check speaker load	Verify that the load does not drop below the specified ohm level
STATUS LED IS ON - RED	Check temperature	Wait for amp to cool down
	Speakers shorted	Check to see if it is the wire or the speakers themselves
SMOKE CAME OUT	Either you spilled your beer on it or did not read this manual and follow the directions	Put smoke back inside
CAN'T KEEP THE OPPOSITE SEX OFF ME	Is volume loud enough for others to hear?	To avoid the opposite sex, buy a different brand of amplifier